

This 7 Series model fits a 1 US quart factory packed round container and comprises the following parts:

- 72 inch clear conductive PVC hose
- 1870 coupling (OMP2506-3 equivalent)
- Stowage point for protection of 1870 coupling
- 1997/45 sight-glass/air bleed valve (includes 45° adaptor)
- 1600 filter element (2 micron beta 200 absolute)
- Stability base
- 'BP TURBO OIL 2380' fluid identification plate



(Assembly shown with packing tube in place of oil can)

The special 2 micron (Beta 200 rated) filter elements fitted to Risbridger equipment dispense filtered fluids to a cleanliness level of DefStan 05/42 (better than 400F or ISO 4406 Class 11/7)

Improve reliability and service life of your aircraft engines and components. Using our quick disconnect couplings and high level filtration you will protect the fluid

- Cans of oil are fitted to the pump before opening, preventing contamination of contents
- Integral can opener and suction pipe
- 'Stowage nose' for 1870 couplings - keeps hose tidy, prevents damage to coupling
- Available for many fluid/aircraft/system types
- Integral 'No Filter - No Flow' safety valve
- Stability base prevents toggle straps collapsing the can and improves sealing

Applicable to the following aircraft models:

Airbus A300, A310, A318, A319, A320, A321, A330, A340, A350 and A380.

Boeing 727, 737, 747, 757, 767, 777 and 787. **Bombardier** Challenger 601, 604, 605, 850, Global Express 5000, 6000, 7000, 8000, CRJ100, CRJ200, CRJ700, CRJ900 and CRJ1000.

COMAC ARJ21. **Embraer** ERJ170, ERJ175, ERJ190 and ERJ195. **Gulfstream** G200, 300, 450, 550, 650, II, III, IV and V. **McDonnell Douglas** DC-8, DC-9, DC-10, MD11 and MD80.

Materials:

Anodised aluminium
Acetal-homopolymer
Zinc plated steel
Stainless steel
Brass

Suitable for:

Engine oils
(clear conductive PVC hoses)

Document Ref:

DATA-7231-150604

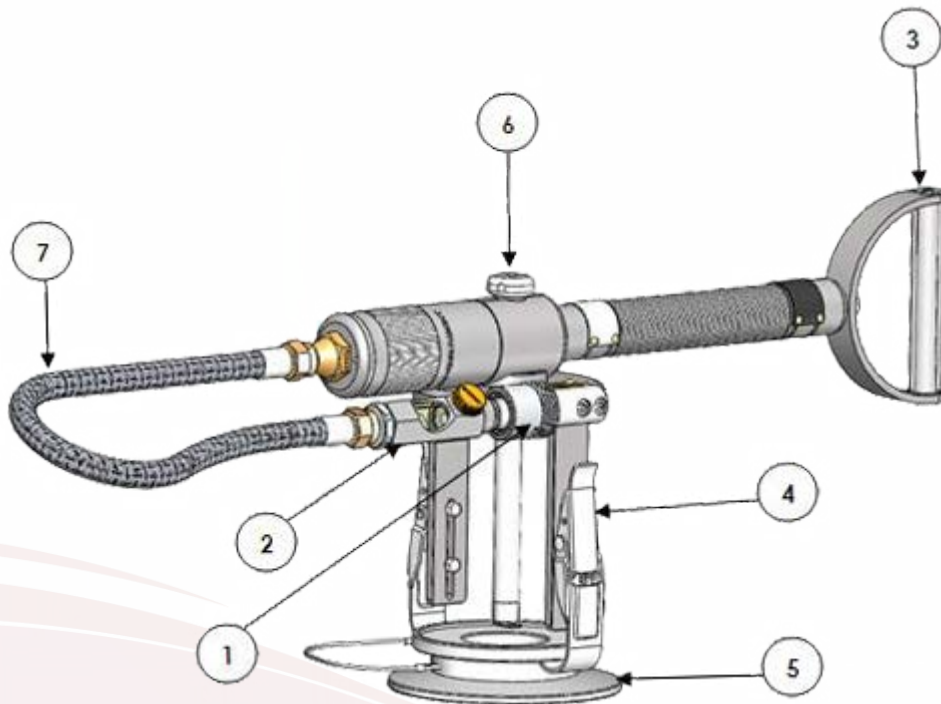

SPARES PART NUMBERS:

Item No	Risbridger Stock Code	Description
1	1870COUPLING	Coupling (OMP2506-3 Equivalent) — Viton™ Seals
	1871	Dust Plug (OMP2506-5 Equivalent) — Viton™ Seals — Not Shown
2	1997	Sight Glass/Bleed Valve Assembly
	1600FILTER	Filter Element (2 Micron Beta 200) — Viton™ Seals — Not Shown
3	UZ7/1	Piston Rod, Handle and Cylinder Assembly
	UZ7/5	Seal Kit c/w Valve (Non Shut-Off and Shut-Off T/P) — Not Shown
4	786/9	Toggles and Straps Only
5	STABILITY-BASE	Stability Base Kit for 7 Series Pumps
6	UZ/E/06	Suction Pipe and Knob (Quart)
7	PC852	36in Clear Conductive PVC Hose
	PC853	54in Clear Conductive PVC Hose
	PC851	72in Clear Conductive PVC Hose

Pump Volume Rating:

1 US quart - 28 strokes
 1 litre - 30 strokes
 2 cu in/33cc/33ml - 1 stroke

Temperature Range:

Engine Oil pumps with clear hose:
 -20°C to +65°C

Mineral Hydraulic pumps with
 clear/black hose: -20°C to +65°C

Manufacturers NCAGE Code:

K6057